

(x)Øxx'-x" TANK

WEIR CIRCUMFERENCE _____xxx.xx'
 BAFFLE CIRCUMFERENCE _____xxx.xx'

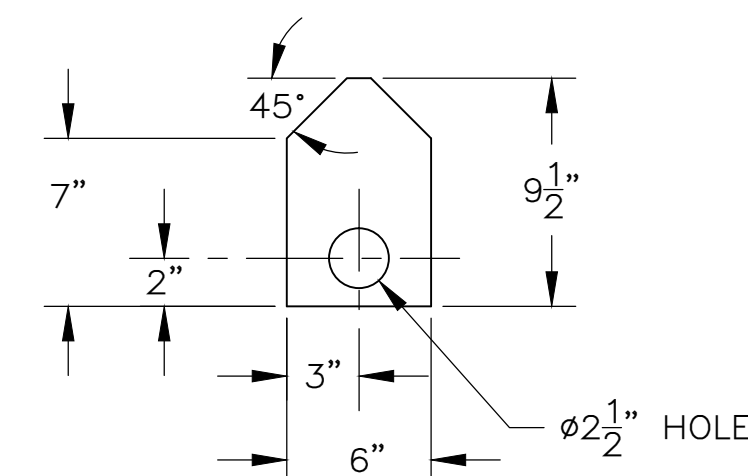

WEIR BUTT PLATE

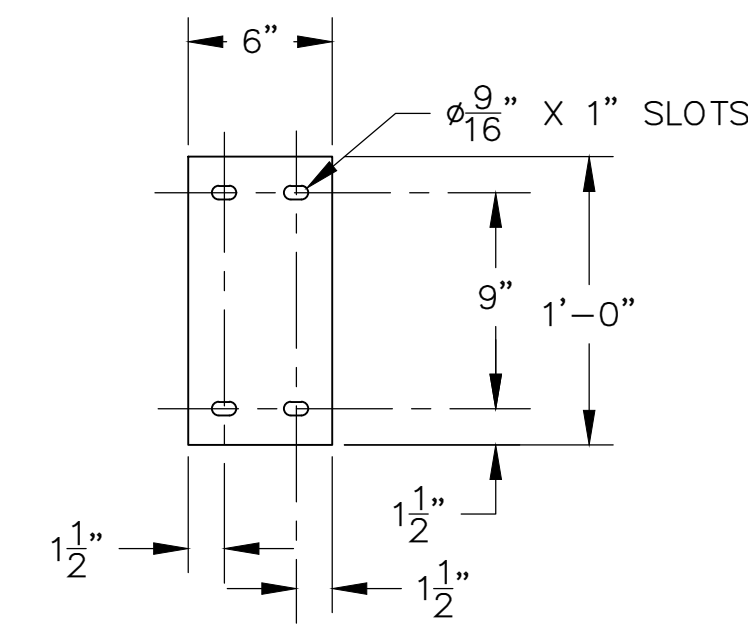

BAFFLE BUTT PLATE

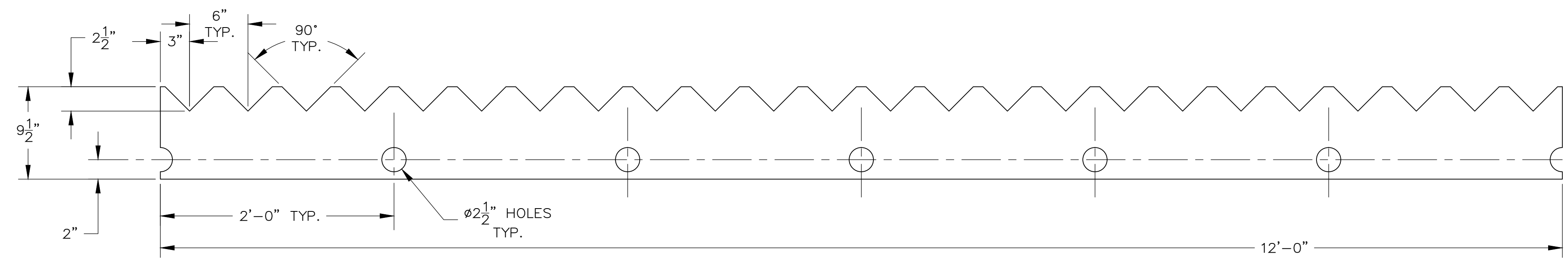

WEIR PLATE

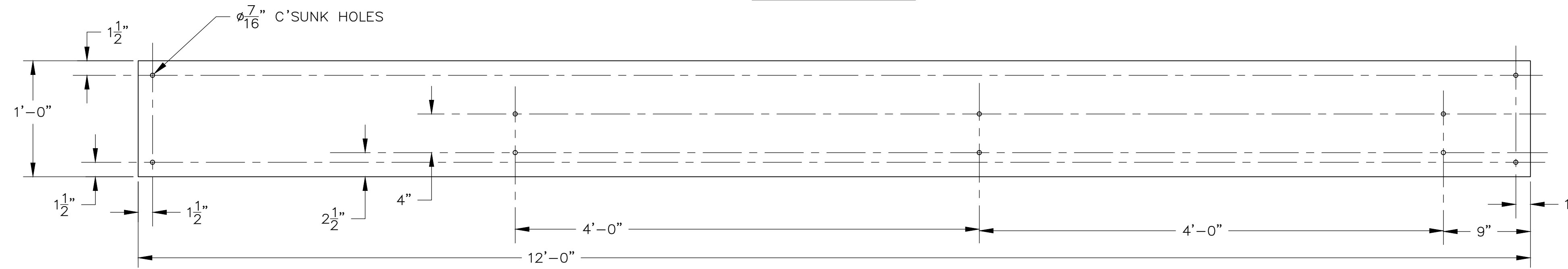

BAFFLE PLATE

*SPACING FOR BAFFLE SUPPORTS AT CONCRETE = x'-xx"

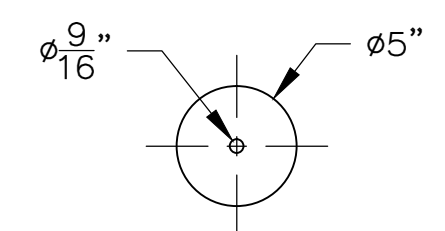

Ø5" WASHER

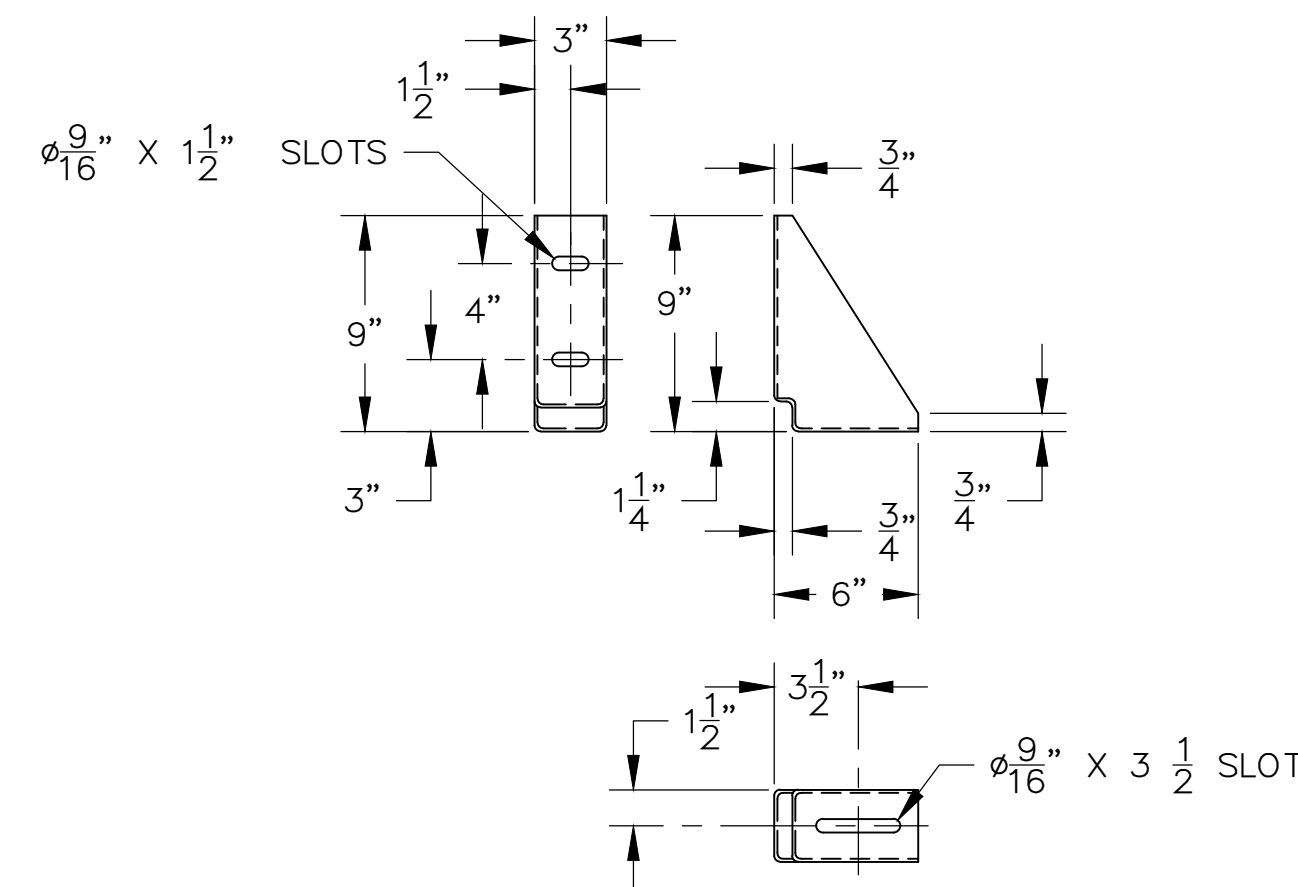

UPPER BAFFLE SUPPORT

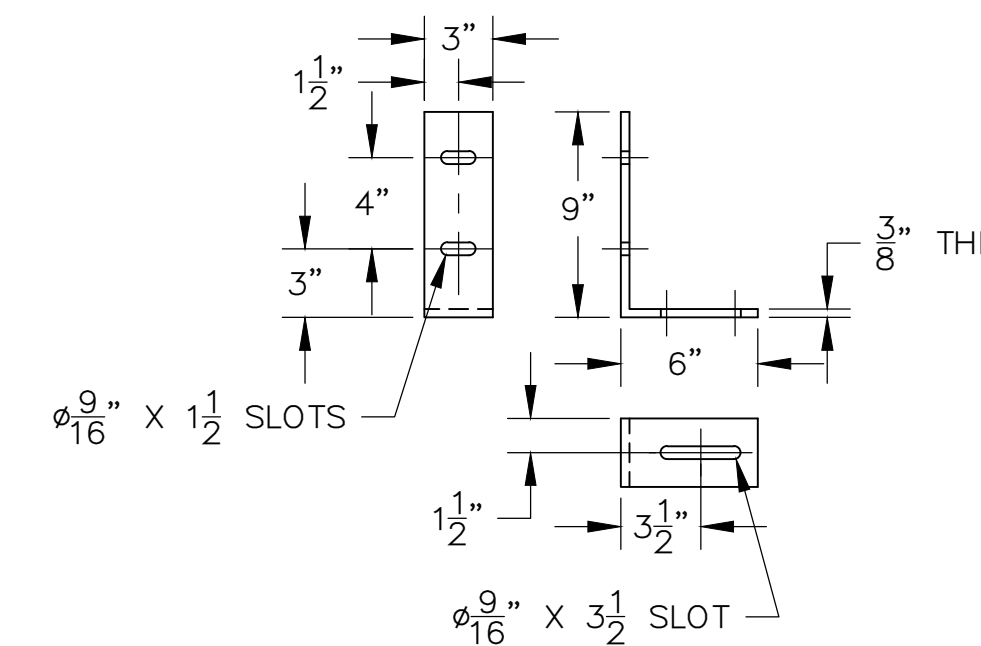

UPPER BAFFLE SUPPORT

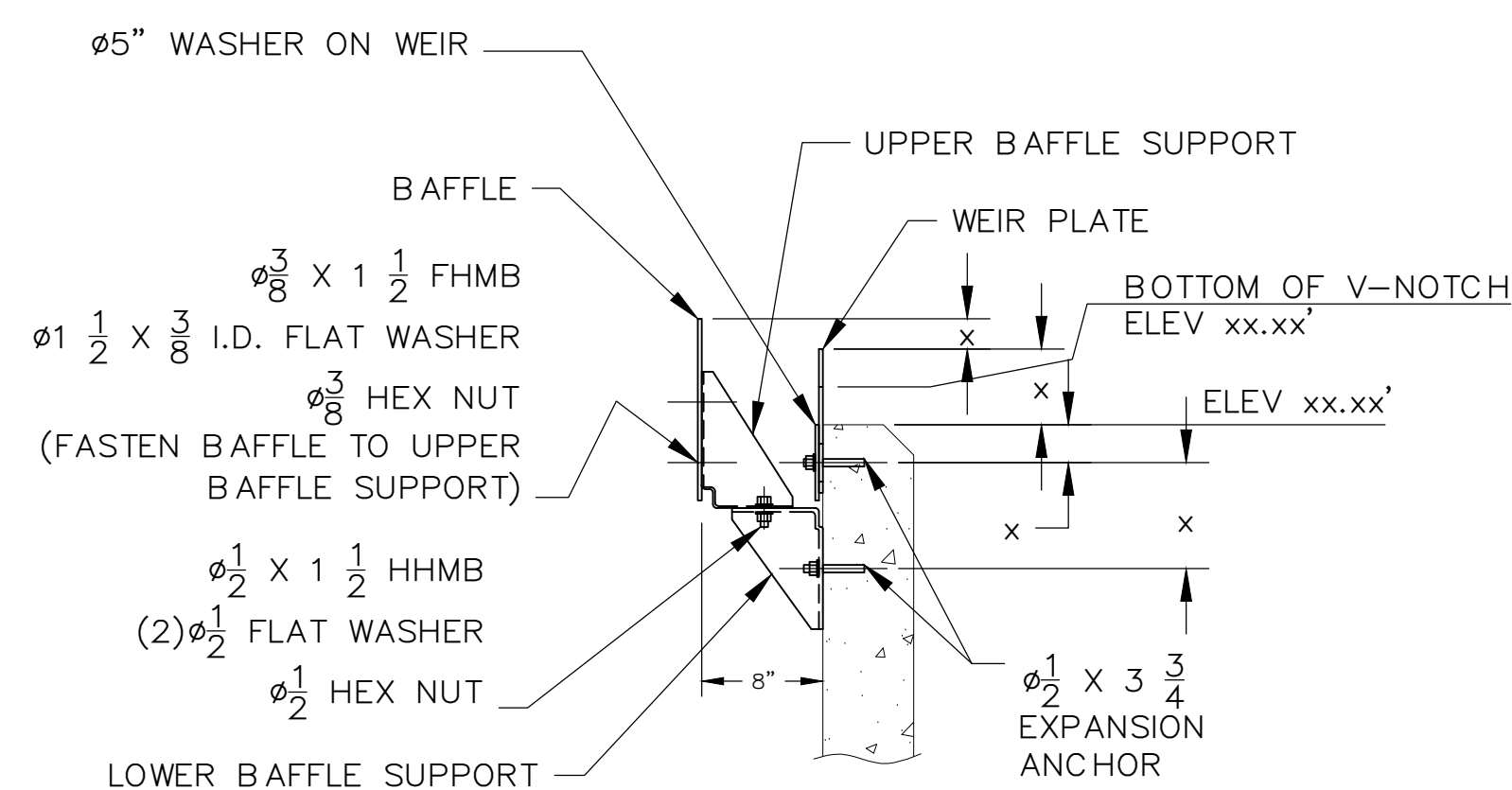

TYPICAL WEIR AND BAFFLE SECTION

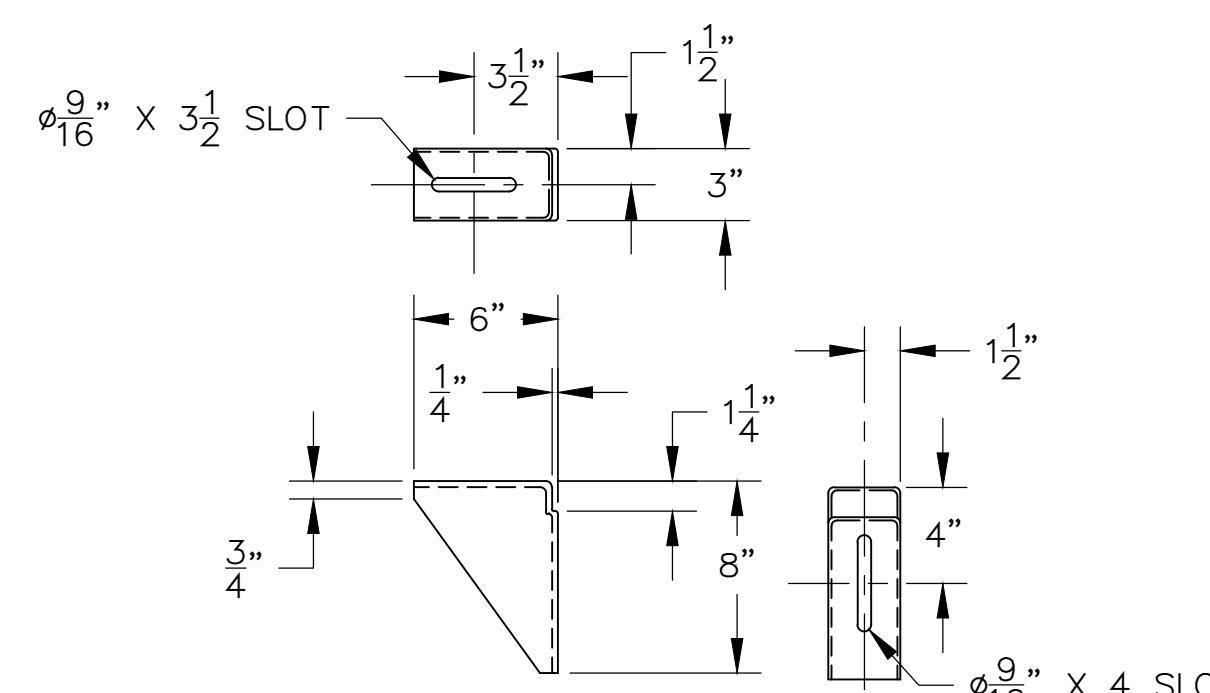

LOWER BAFFLE SUPPORT

TYPICAL SUPPORT STYLE

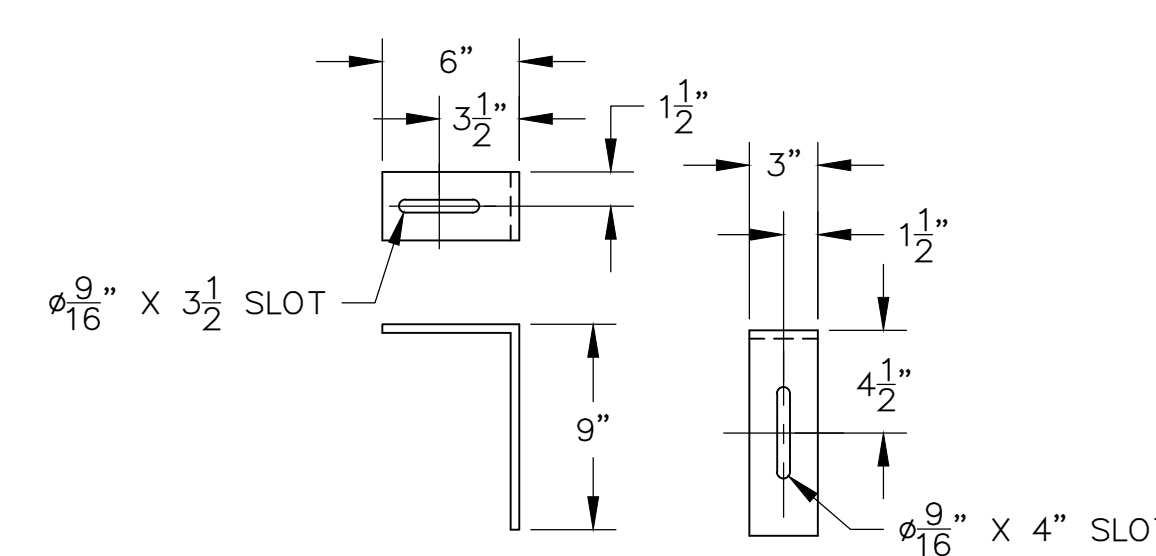

LOWER BAFFLE SUPPORT

SUPPORT STYLE WHEN ALGAE SWEEP SYSTEM IS PRESENT

MFG WATER TREATMENT ("WATRE") has no responsibility for the contract design of the product or the contract specifications. WATRE has been selected to manufacture this product, the customer agrees to indemnify and hold WATRE harmless from and against all liability relating to this product, its performance, merchantability and fitness for purpose (including all liability for claims, suits, judgements and expenses), unless the product as manufactured by WATRE does not conform to the contract design and specifications set or WATRE'S shop drawings approved by the customer.

NO.	REVISIONS	DATE

MFG CONSTRUCTION & WATER PRODUCTS
 55 4th AVENUE UNION CITY, PA 16438 PHONE: (814) 438.3959 FAX: (814) 438.8538
 SCALE TITLE: Weir and Baffle Typical Details

DIVISION : MFG/WTP
DRAWN BY : x
CHECKED BY :
APPROVED :
DATE : x

SHEET NO.
x